



## Installation instructions

Akrapovič Exhaust System:  
**Slip-On**  
for the  
**Honda CBR1000RR**



\*504325\*

**Congratulations on purchasing an Akrapovič exhaust system. Please read the entire installation manual prior to undertaking any activities related to installation of your new Akrapovič exhaust system. In case you do not fully understand the manual or any of its parts, please contact your authorized dealer!**

**This product should be installed by someone with sufficient knowledge of exhaust systems and their installation, and appropriate hand or power tools. If you are not qualified for this work, please utilize a certified mechanic for installation. By installing Your Akrapovič exhaust system, you indicate that you have read the installation manual in its entirety and you agree with the terms stated herein.**

**It is your responsibility to follow all installation instruction guidelines supplied with the Akrapovič exhaust system and undertake all necessary safety precautions. Akrapovič d.d. assumes no responsibility for damages occurring from misuse, abuse, improper installation, improper operation, lack of responsible care, or all previously stated reasons resulting from incompatibility with other manufacturer's products and/or systems.**

## **IMPORTANT INFORMATION**

### **Exclusion of Certain Liability**

1. The manufacturer, importer or dealer shall not be liable for any incidental damage including personal injury or any other damages caused by improper installation or operation of the Akrapovič exhaust system. When installing the Akrapovič exhaust system be careful that the exhaust system does not touch other parts sensitive to high temperature.
2. Akrapovič makes no representation or warranties with regard to damage caused by the improper installation, use and maintenance of the Akrapovič exhaust system. The warranty is limited to defects recognized by our technical department and due to normal use, and excludes items subject to normal wear (gaskets and damping wool). The guarantee is void in case of accident, modification, improper or competition use.
3. Do not attempt to install the Akrapovič exhaust system on a vehicle model for which it was not made or tested by Akrapovič.
4. When the exhaust system gets very hot during operation, be careful not to burn yourself on the exhaust system or parts which are in direct contact with it, even when the engine is not running. Also protect other people, especially children, from the injuries mentioned above.
5. In some cases Akrapovič exhaust system kits contain chemical products (ceramic anti-seizing grease; bolt sealant). Handle with care, do not inhale or swallow. Avoid excessive contact with skin, eyes or mucous membranes. Keep out of reach of children.
6. Technical specifications of Akrapovič exhaust systems and related products are subject to change without notice.
7. Before removing the original exhaust system from your vehicle, please compare the parts you received with the list of materials provided in the installation manual in order to assure that you have all the parts necessary for the installation of your new Akrapovič exhaust system.
8. Although this manual consists of instructions for installation in written form, as well as photographs and pictures representing individual steps of the installation, please note that the photographs and pictures are symbolic and are intended for representation of general overview only. The photographs and pictures contained herein should serve as a guideline only and actual installation of the exhaust system may not correspond with the photographs and pictures entirely.
9. The process of uninstalling the original exhaust system may vary depending on the existing exhaust system. Please follow the original exhaust system manufacturer's instructions for uninstalling the original exhaust system.

### **Trademarks**

The Akrapovič Exhaust System Technology logo is a registered trademark of Akrapovič d.d.

### **Akrapovič website**

Information about Akrapovič exhaust systems and related products is available on the Akrapovič website at: <http://www.akrapovic.com/>

### **Copyright**

No part of the Akrapovič exhaust system or its documentation may be reproduced or distributed in any form or by any means without the prior written authorization of the Akrapovič company.

© Akrapovič, d.d. All rights reserved.

## Symbols

The following symbols are used throughout these installation instructions:



TOOLS REQUIRED



TIGHTENING TORQUE



INSTALLATION TIP



CAUTION OR WARNING



**USE BOLT SEALANT;** Apply 3 to 4 small drops of bolt sealant onto the cleaned and degreased threads before tightening the bolts. **WARNING! Avoid contact with skin, eyes and mucous membranes. Do not inhale fumes. Keep out of reach of children.**



**USE ANTI-SEIZE LEAD-FREE COPPER PASTE** (black tube); Provides trouble-free and long-lasting protection against seizing, corrosion and rusting of bolts, threaded ends, nuts, joints, etc. Also protects against vibration, wear and impact. **WARNING! Avoid eye contact. Avoid excessive skin contact. Keep out of reach of children.**



**USE ANTI-SEIZING GREASE** (white tube); Prevents seizing, corrosion and excessive wear between the titanium components of your exhaust system. **WARNING! Avoid eye contact. Avoid excessive skin contact. Keep out of reach of children.**

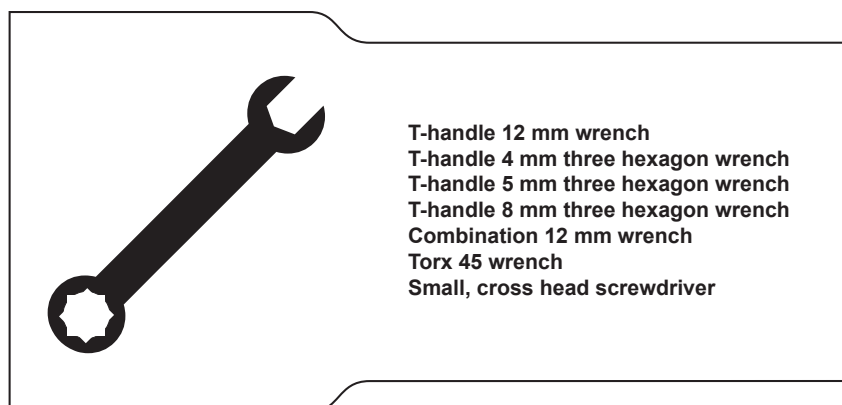

**BEFORE INSTALLING, CHECK THE PARTS LIST AND SCHEMATIC DRAWING OF THE EXHAUST SYSTEM! THE LATEST VERSION OF THE PARTS LIST AND SCHEMATIC DRAWINGS OF THE PRODUCTS ARE AVAILABLE ON OUR WEB PAGE.**



**IF ANY ITEMS IN THE AKRAPOVIČ EXHAUST SYSTEM PACKAGE ARE MISSING, PLEASE CONTACT YOUR AUTHORIZED DEALER. KEEP THE SCHEMATIC FOR FUTURE REFERENCE.**



**THESE INSTALLATION INSTRUCTIONS MUST BE READ CAREFULLY IN ORDER TO ENSURE PROPER INSTALLATION AND OPERATION OF THE AKRAPOVIČ EXHAUST SYSTEM.**



**THE EXHAUST SYSTEM CAN BE EXTREMELY HOT. ALLOW THE EXHAUST AND ENGINE TO COOL DOWN BEFORE BEGINNING INSTALLATION.**



**WE ADVISE YOU TO LEAVE INSTALLATION TO A QUALIFIED SERVICEMAN. IMPROPER INSTALLATION MAY RESULT IN A SHORTER LIFETIME OF THE EXHAUST SYSTEM AND/OR DAMAGE TO THE VEHICLE.**



**THIS MANUAL IS SPECIFIC TO THE HONDA CBR1000RR ABS M.Y.2014. THERE MAY BE SOME DIFFERENCES IN INSTALLATION PROCEDURES FOR OTHER CBR1000RR MODELS.**



**AKRAPOVIČ MAKES EVERY EFFORT TO PROVIDE IMPROVED CORNERING CLEARANCE FOR EXHAUST SYSTEMS. HOWEVER, DUE TO DESIGN AND SPACE LIMITATIONS ON SOME MOTORCYCLE MODELS, GROUND AND CORNERING CLEARANCE MAY NOT IMPROVE OR MAY EVEN BE REDUCED. FOR ADVANCED USERS, WE RECOMMEND INCREASING THE SPRING PRELOAD SETTINGS TO IMPROVE GROUND CLEARANCE.**



**THE AKRAPOVIČ WARRANTY DOES NOT COVER DISCOLORATION OF ANY CHROME PRODUCTS.**

**REMOVAL OF STOCK EXHAUST SYSTEM:**

1. Put the motorcycle on a side stand, we recommend a racing stand. Make sure, that surface is solid and flat.
2. Undo the marked plastic fasteners and carefully remove the servo motor's cover (Figure 1).

**! CAUTION:** be careful not to damage any part of the motorcycle during this process!

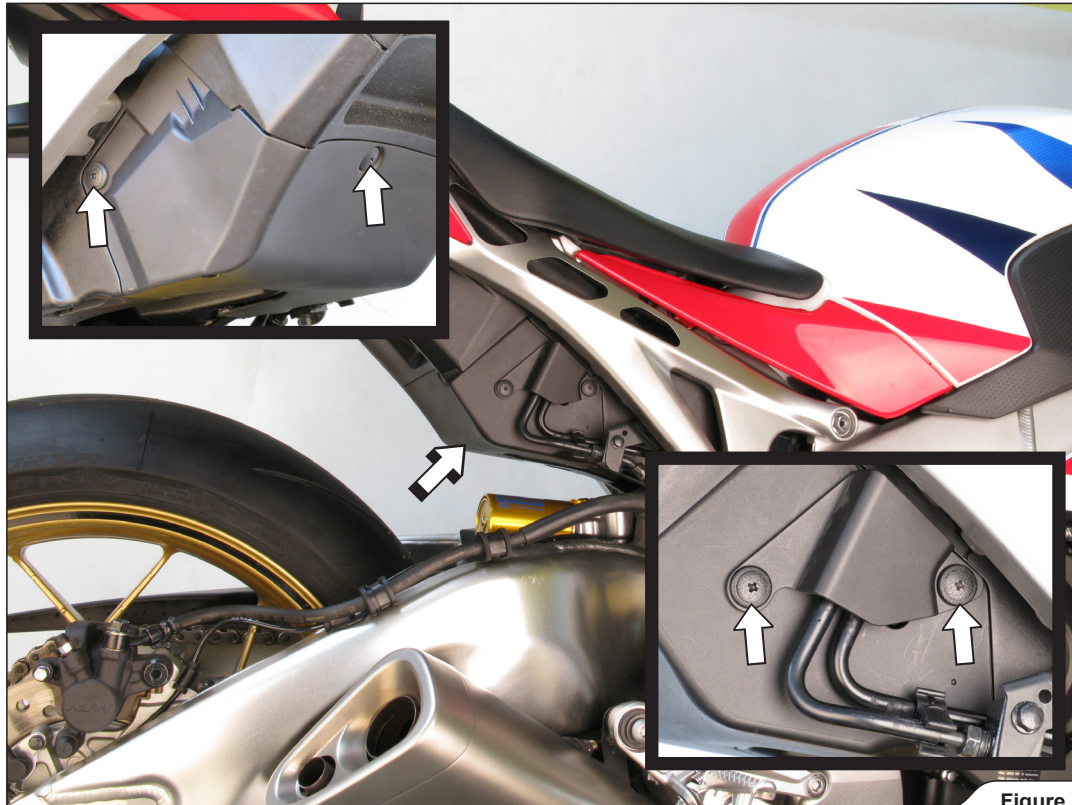

Figure 1

3. Slightly rotate the servo motor in the marked direction and remove the cable off the servo motor (Figure 2).

**! CAUTION:** be careful not to damage any part of the motorcycle during this process!

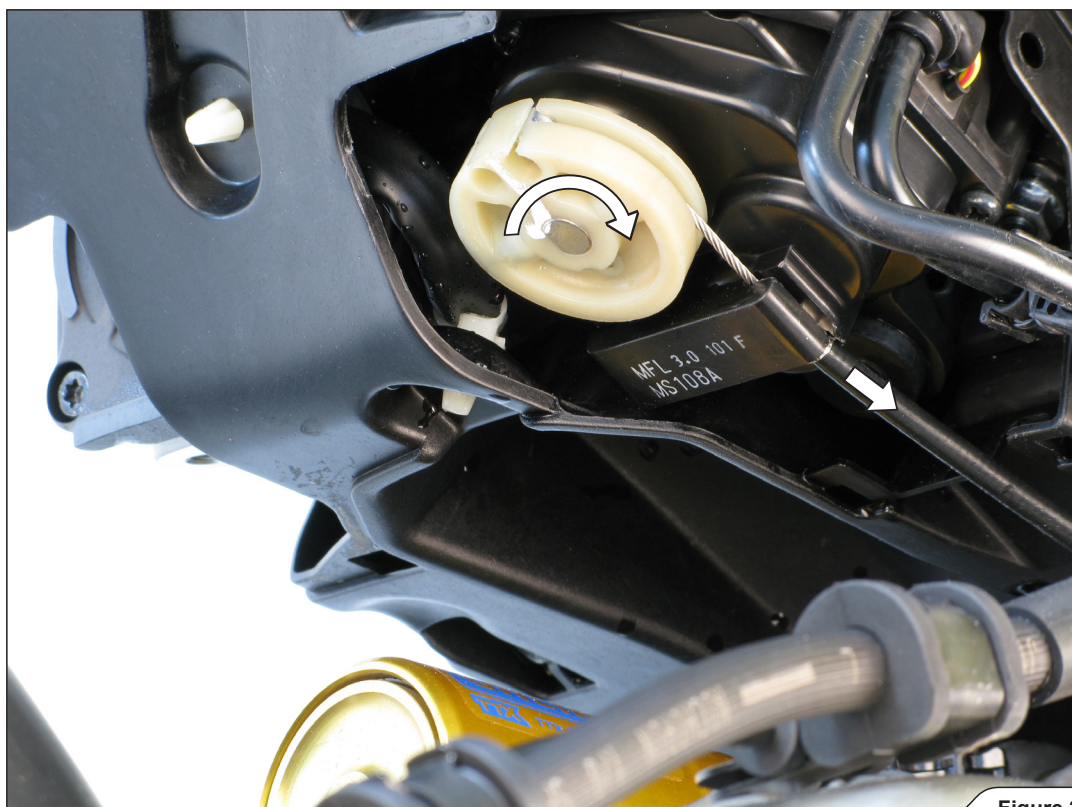

Figure 2

4. Loosen the marked clamp (**Figure 3**).

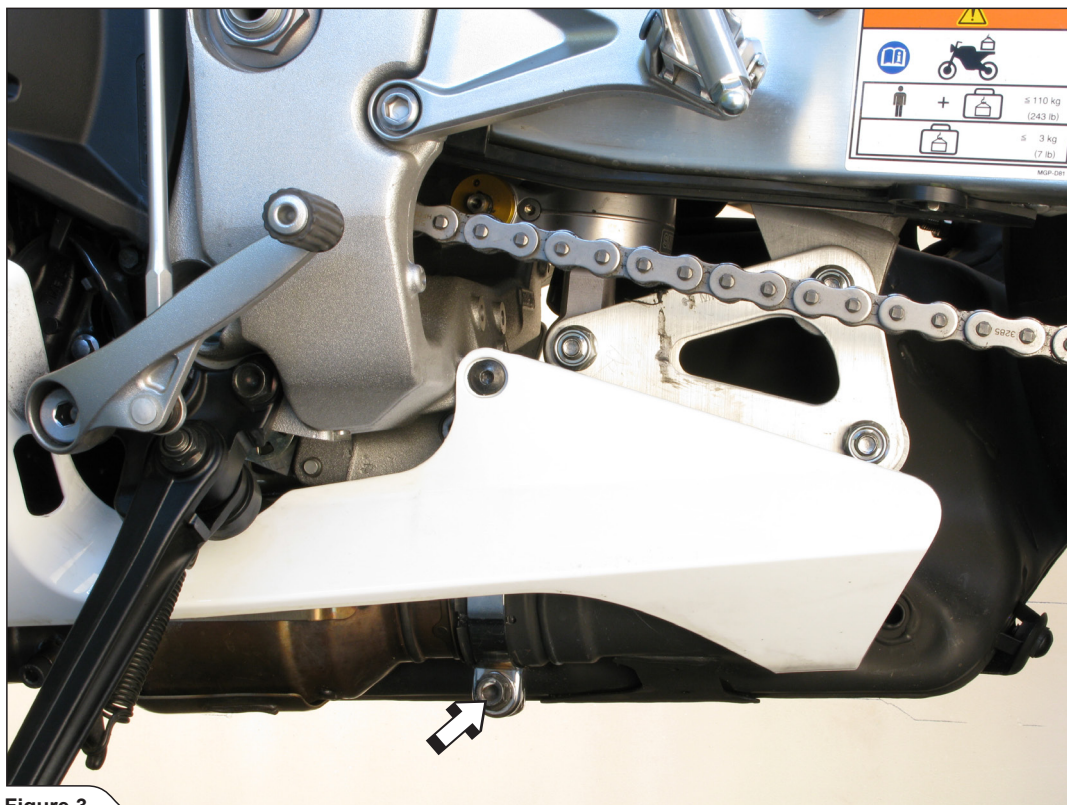

Figure 3

5. Unscrew the muffler's bracket bolt and carefully remove the muffler off the motorcycle (**Figure 4**).  
**! CAUTION:** be careful not to damage any part of the motorcycle during this process!



Figure 4

6. Remove the marked rubber dampers and the metal collar from the muffler's bracket and unscrew the footrest bolts (Figure 5, 6).

! **CAUTION:** be careful not to damage any part of the motorcycle during this process!

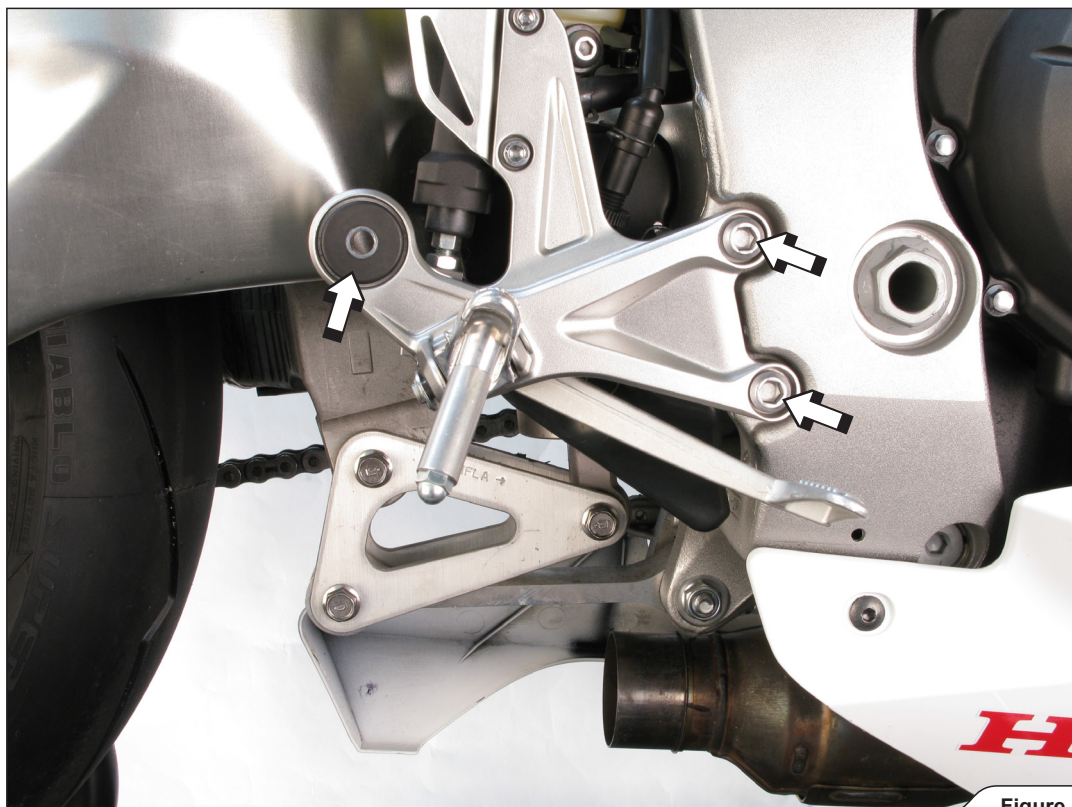

Figure 5

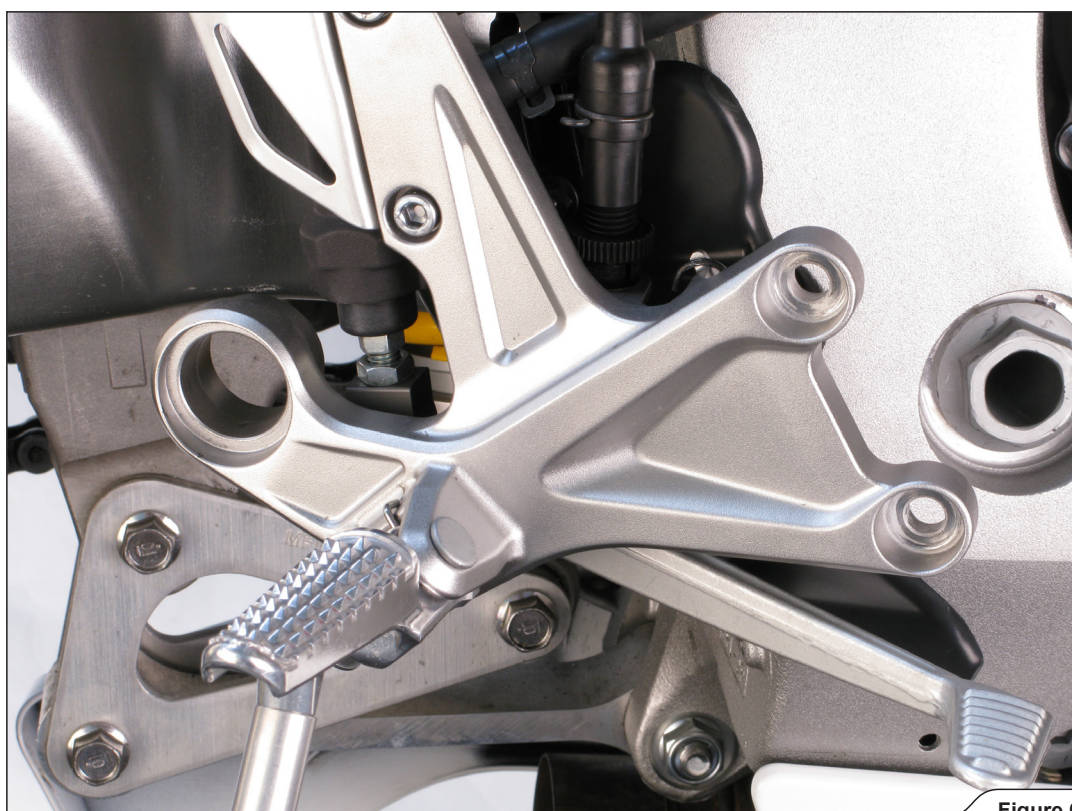

Figure 6

**INSTALLATION OF THE AKRAPOVIČ SLIP-ON EXHAUST SYSTEM:**

1. Put the 5 mm aluminium spacers from Akrapovič installation kit under the footrest and reattach the footrest with the stock bolts (Figure 7).

**! CAUTION:** be careful not to damage any part of the motorcycle during this process!

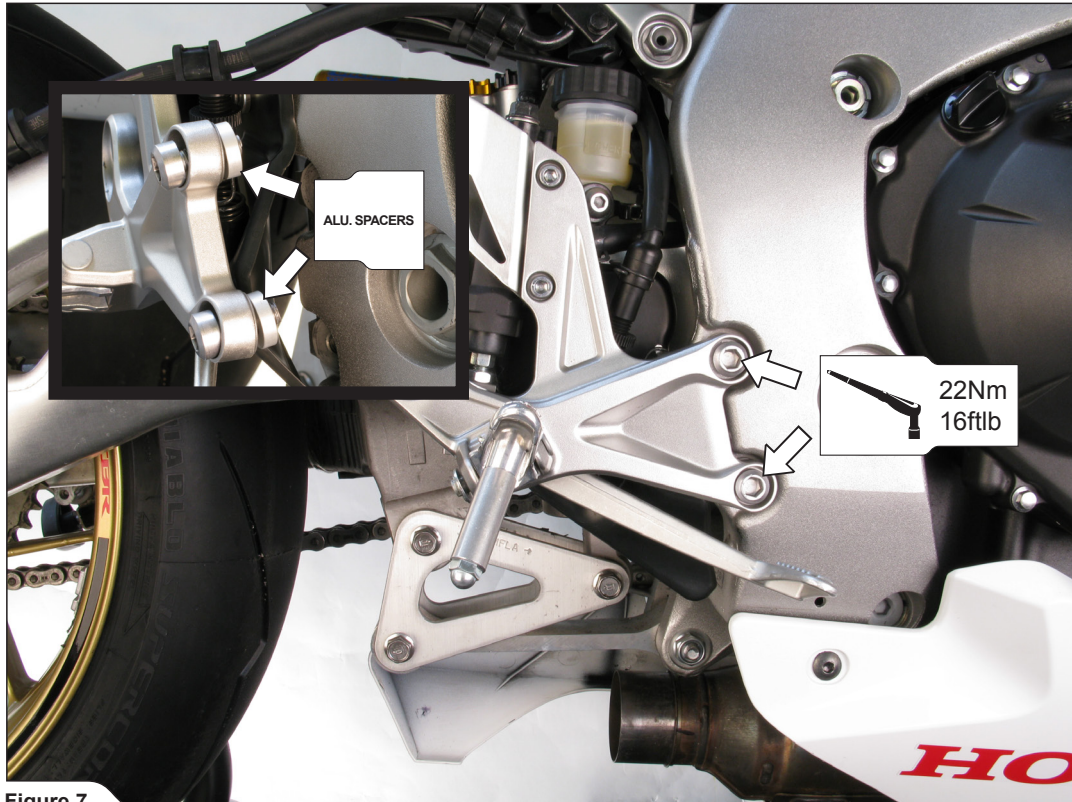

Figure 7

2. Insert the aluminium bush from Akrapovič installation kit into the muffler's bracket (Figure 8).

**! CAUTION:** be careful not to damage or scratch the swing arm during this process!

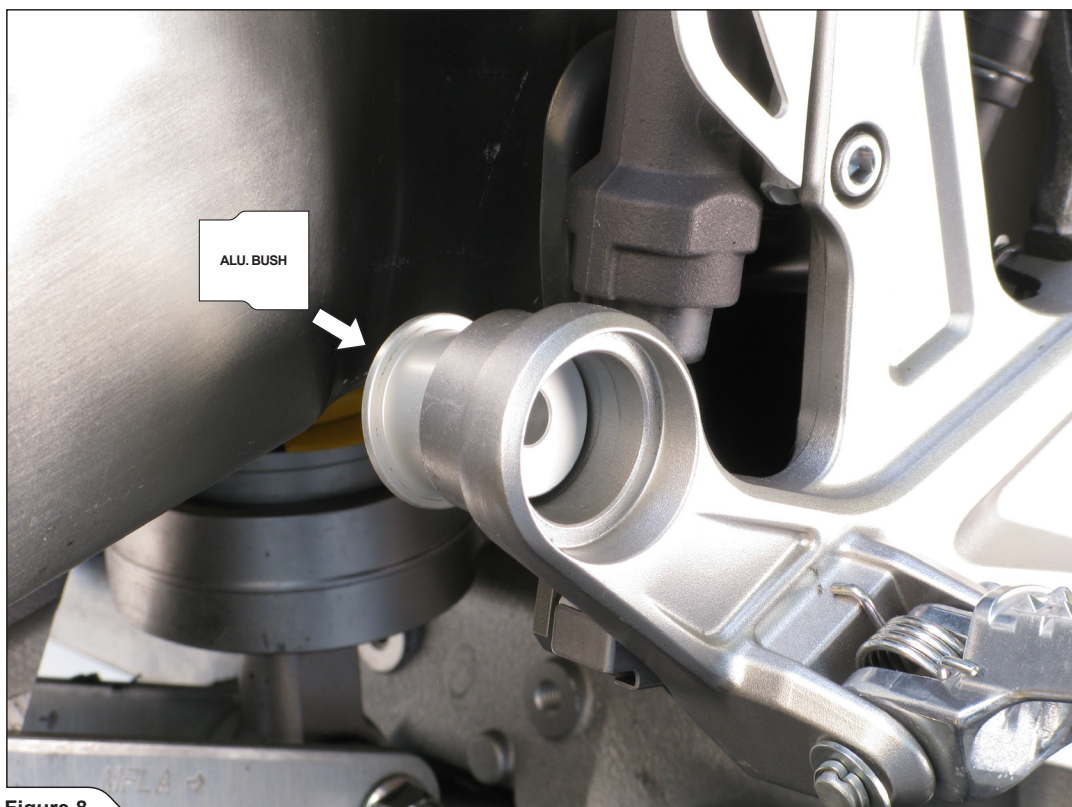

Figure 8

3. Correctly orient and assemble the clamp from Akrapovič installation kit onto the muffler's inlet pipe, as shown (Figure 9).

! **WARNING:** use anti-seize copper paste on clamp's bolt threads!



Figure 9

4. Slide the muffler onto the stock collector (Figure 10).

! **CAUTION:** be careful not to damage any part of the motorcycle during this process!



Figure 10



5. Hand tighten the muffler onto the stock bracket using bolt, washers, aluminium washer and nut from Akrapovič installation kit (Figure 11).

! **WARNING:** do not fully tighten the bolt yet!

! **CAUTION:** be careful not to damage or scratch any part of the motorcycle during this process!

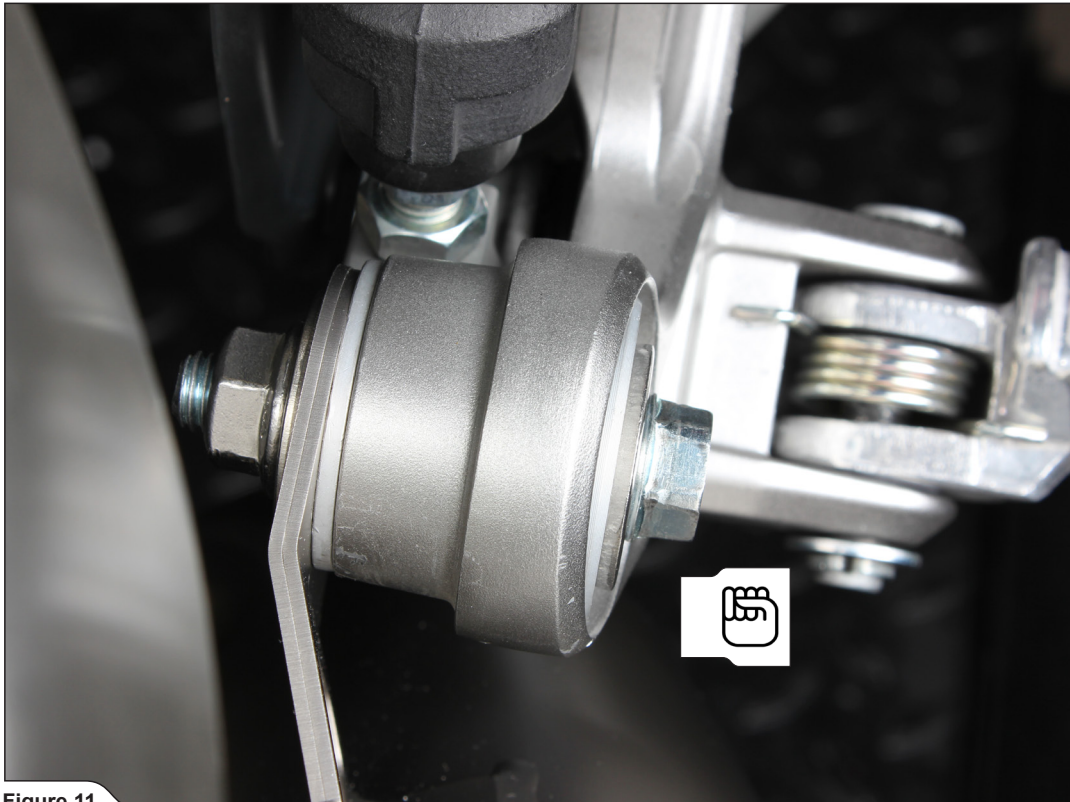

Figure 11

6. Align the muffler in respect to the motorcycle and tighten the marked bolt and clamp to the specified torque (Figure 12, 13).

! **CAUTION:** be careful not to damage any part of the motorcycle during this process!

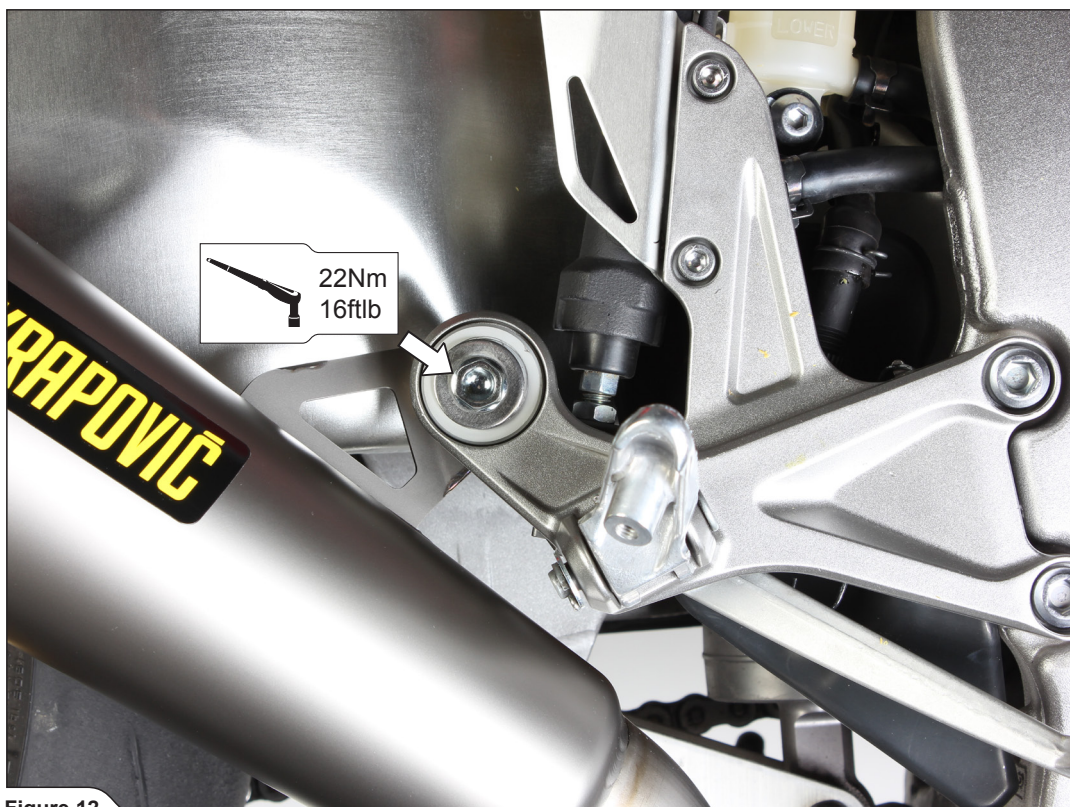

Figure 12

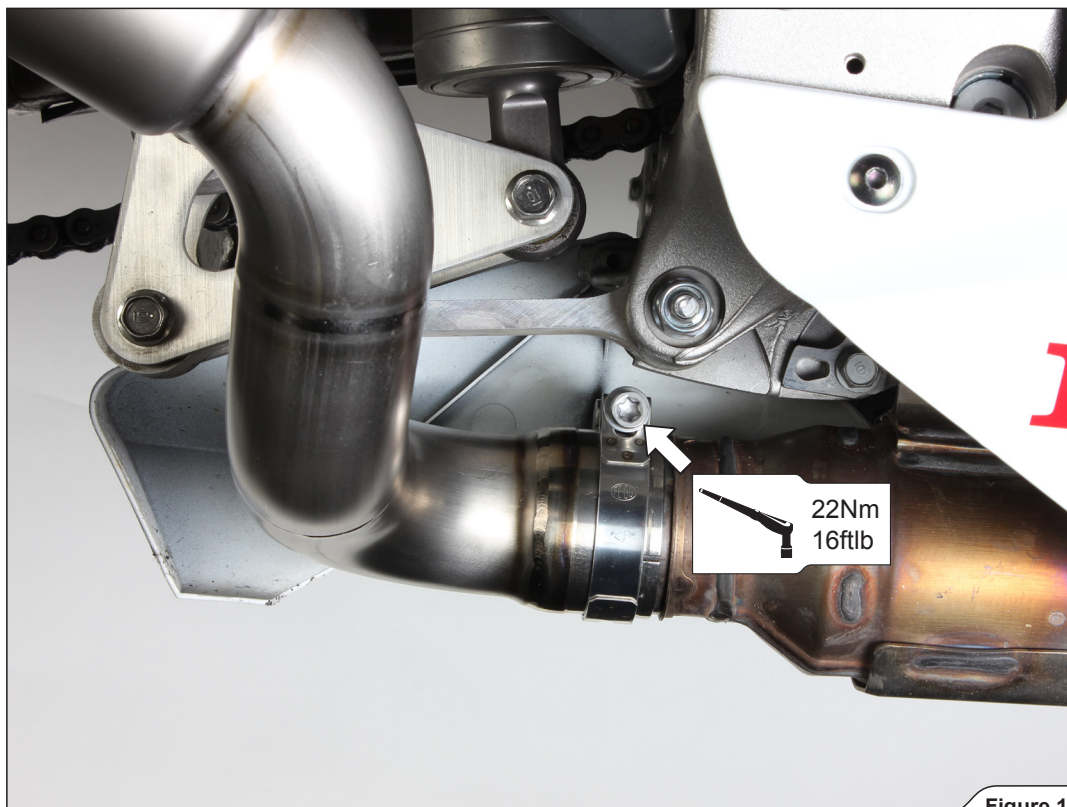

Figure 13

7. Reattach the cover of the servo motor in the reverse order from the order in which it was removed (Figure 14, 15).  
**! CAUTION: be careful not to damage any part of the motorcycle during this process!**



Figure 14

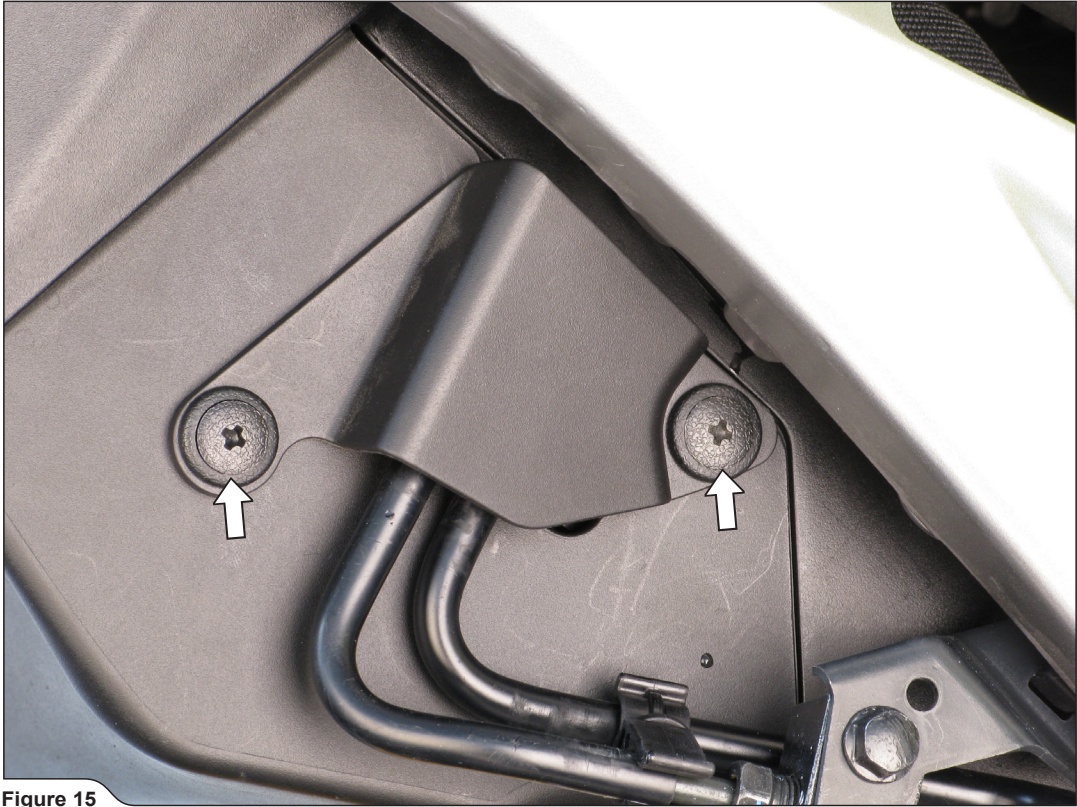

Figure 15

**Final installation:**

Clean grease spots:

- a. Muffler – titanium outer sleeve: use a soft cloth sprayed with a multi-purpose spray lubricant (WD-40 or equivalent).
- b. Muffler – carbon-fiber outer sleeve: use a soft dry cloth.
- c. Muffler – carbon-fiber outlet cap: use a soft dry cloth.
- d. Stainless steel pipes: use a soft cloth sprayed with a contact cleaner, then wipe with a soft dry cloth.
- e. Chrome plated parts: use a soft dry cloth.
- f. Titanium pipes: use a soft cloth sprayed with a multi-purpose spray lubricant (WD-40 or equivalent).

Cleaning will prevent spots from burning onto the surface. Do not use aggressive chemical cleaners, because they can damage the sticker.

**! WARNING: make sure all the bolts are sufficiently tightened. In case the exhaust system touches the cowling or other parts repeat the adjustment of the exhaust system or contact your authorized dealer.**

**! WARNING: after running engine for 30 minutes, retighten the bolts of the Akrapovic carbon-fiber heat shield!**

**! IT IS NORMAL IF WHITE SMOKE COMES OUT OF THE MUFFLER ON FIRST OPERATION.**

**! DO NOT STAND BEHIND THE MUFFLER ON FIRST OPERATION.**

**! DO NOT USE AUTOMOTIVE WHEEL CLEANERS OR ANY CLEANING PRODUCTS WHICH CONTAIN ACIDIC ADDITIVES TO CLEAN AKRAPOVIČ EXHAUST SYSTEMS.**

**MAINTENANCE OF THE AKRAPOVIČ EXHAUST SYSTEM:**

1. Clean the titanium exhaust components with a multi-purpose spray lubricant (WD-40 or equivalent), carbon fiber exhaust components with soft and dry cloth and stainless steel components with soft cloth sprayed with contact cleaner, then wipe with soft and dry cloth. A change in the color of the exhaust system is normal due to the high temperatures.
2. Periodically make sure all the bolts and springs are sufficiently tight.

**WARNING:**

Please note that certain aftermarket exhaust systems may not comply with applicable California laws and regulations, and may therefore be prohibited for use on California highways or roads, or on roads or vehicles otherwise subject to emissions control requirements.

Akrapovič exhaust systems for automobiles and motorcycles mounted downstream of the catalytic converter (also known as “cat-back systems”) are considered “replacement parts” in California by the California Air Resources Board (CARB), and do not require an exemption or executive order from CARB to be sold in California. However, California prohibits the use of any aftermarket exhaust system that modifies, removes or replaces original equipment catalysts, unless CARB has issued an Executive Order as to such part or system.

Further, Akrapovič parts or exhaust systems used or intended for use on “racing vehicles” (i.e. a competition vehicle used exclusively for competition on closed-course circuits) do not require an exemption or Executive Order from CARB to be sold in California. However, such parts are prohibited from use on California public highways or roads, even if occasionally used “off-road.”



